

9" CATCH BASIN FILTER

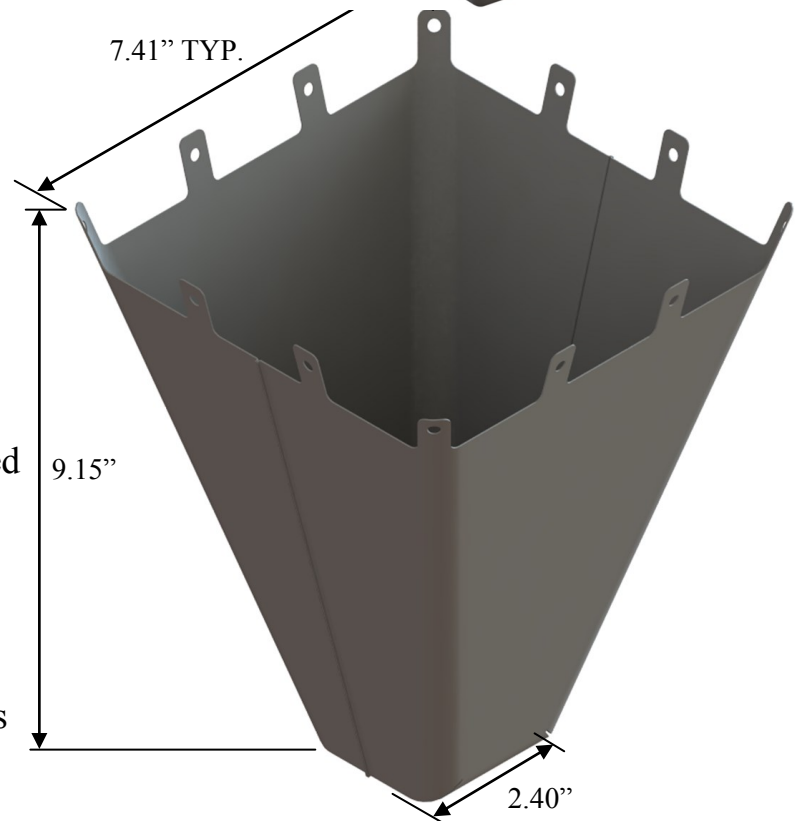
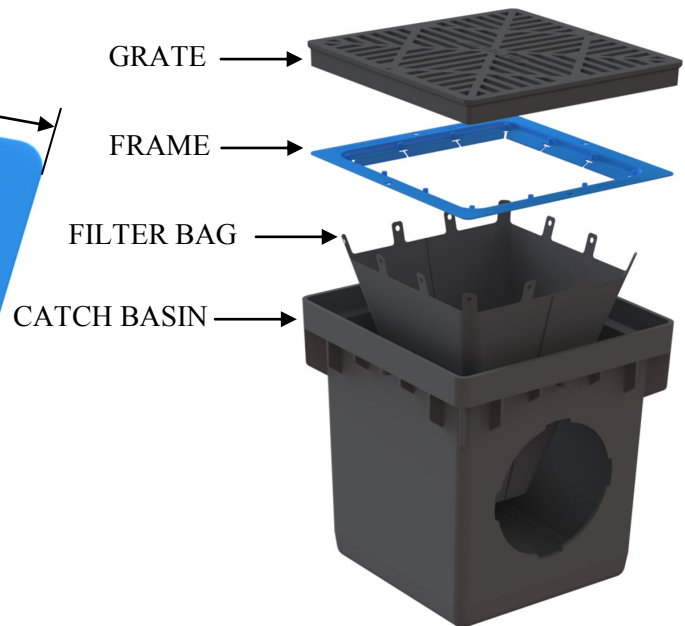
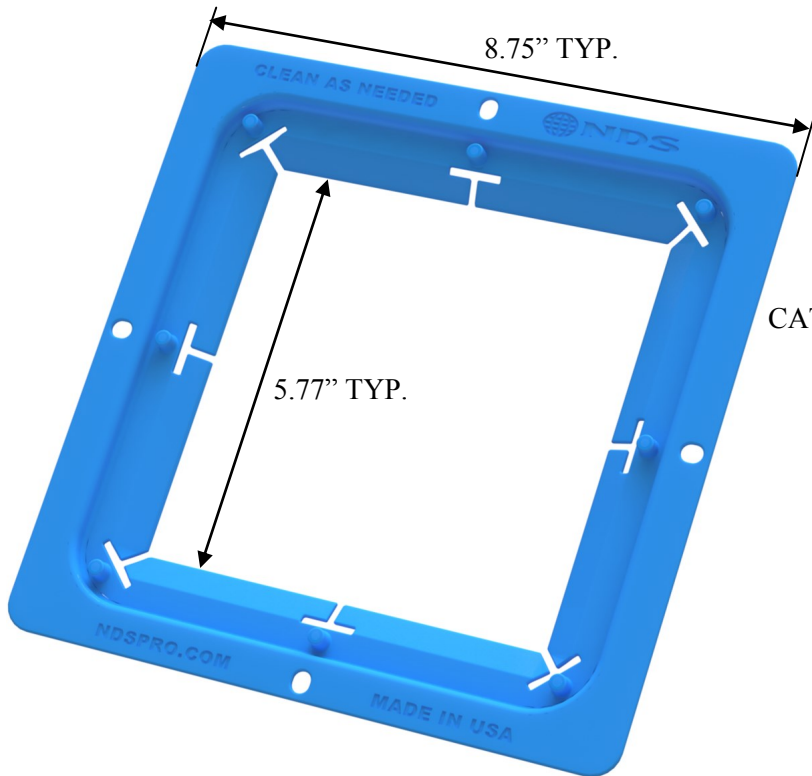

Part #: 900FF

Frame Material: Polypropylene

Body Color: Blue

Filter Bag Material: Nonwoven spunbonded, polypropylene geotextile. Inert to biological degradation and resistant to naturally encountered chemicals, alkalis and acids.

Water Flow Rate: (ASTM D 4491) 95 GPM/sf

Opening Size: 50 US Std. Sieve

Trapezoidal Tear: (ASTM D 4533) 40 lbs.

UV Resistance: (ASTM D 4355) 70% @ 500 hrs

Fits: 9" NDS Catch Basins

Weight: 0.06 lbs.

Supplied By:

**TRENCHDRAIN
SUPPLY**

877-903-7246

www.trenchdrainsupply.com